

Athletic

BEST FOR LIFE

ACADEMY 1600MB

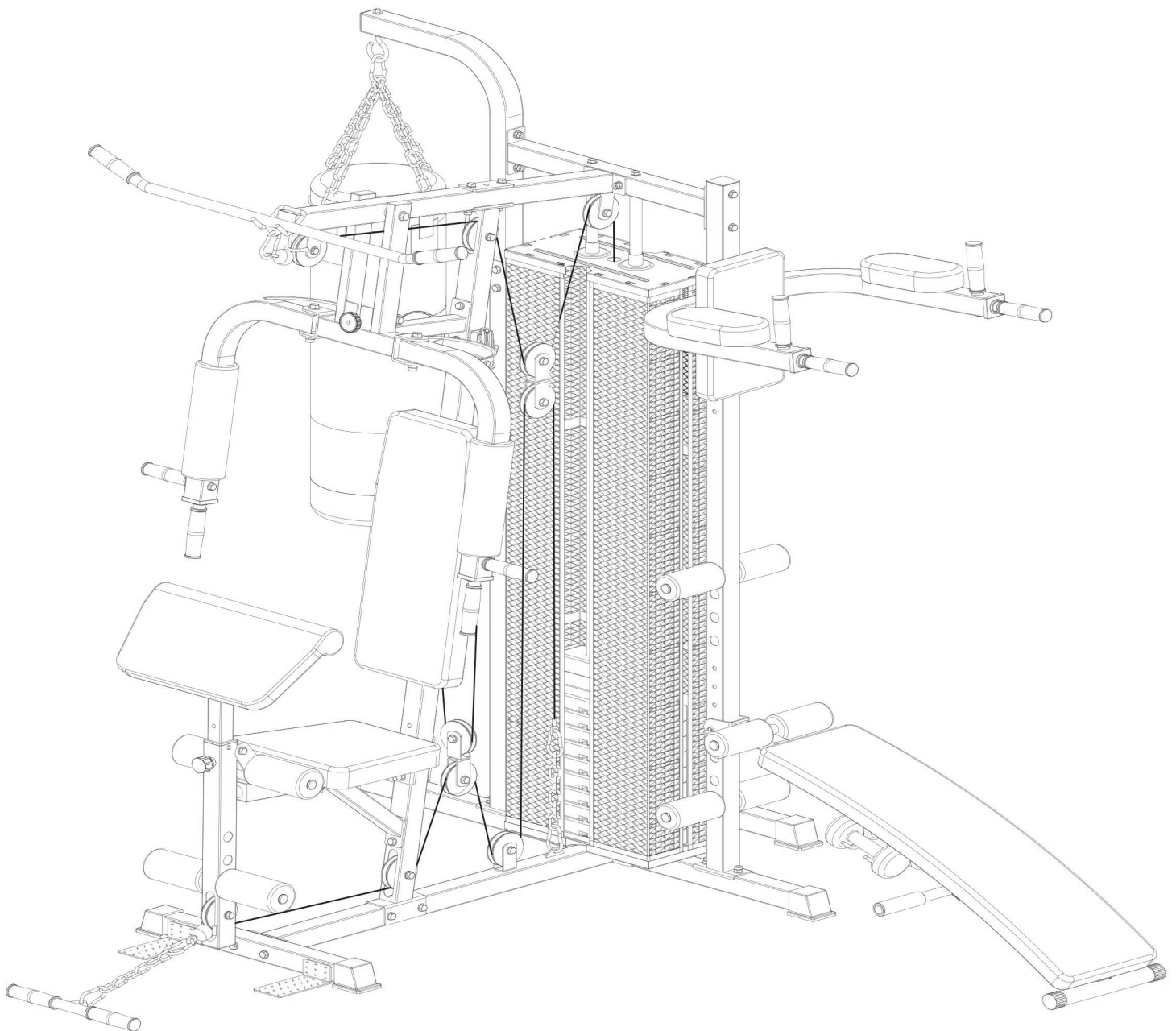

Content

1. safety instructions.....	2
2. product overview	3
3. part list / exploded view	4
4. installation	6
5. operation and use of the item.....	12
5.1 location.....	12
5.2 before training	12
5.3 the training	13
6. cleaning and maintenance	15
7. disposal.....	15
7.1 disposal of packaging.....	15
7.2 Disposal of appliance	15

1. safety instructions

This weight station is made for training in private environment. Only use the appliance for the intended use.

It is not allowed to change anything which can have effects to the security of the product.

Warning!

Pregnant or physical injured people should never use the weight station without prior consultation with a doctor you trust.

Stop the training immediately when you do not feel comfortable or notice motoric, sensory or mental changes / imitations.

Adapt your training style always to your personal fitness level and your health.

Before every training check the operability and safety.

Make sure before installation that the item is properly and that all safety devices are functional!
Damages or alterations to the product in the course of the independent modification lead to the exclusion of warranty. For problems resulting from the modification or other restrictions, the seller is not responsible!

Any damage must be reported to the seller immediately after delivery, and access before use / installation. Later complaints will not be considered.

Use only suitable tools for assembly.

Other than the people who run the Assembly have not stay in the immediate area.

The installation must always be made only by adults.

Children should not be present in the immediate environment.

In part, the package may consist of plastic bags - make this regard with particular care and attention that this is not out of the reach of children. There is a risk of suffocation!

Make sure to mount that all connections are securely mounted before releasing the product for use.

Check all connections at regular intervals for damage, loose elements and other factors that can lead to a loss of sufficient security.

Do not leave children unattended on the weight bench! It is not a toy!

Instruct them not to play or climb with or on the appliance.

This device consists partly of small parts-keep you particularly young children and babies away from this unit (Choking hazard because of small parts)!

In case of damage or other abnormalities they break the installation immediately. If abnormalities or damage after installation in day to day use or maintenance occur lock the bike to use in order to prevent any risk of injury.







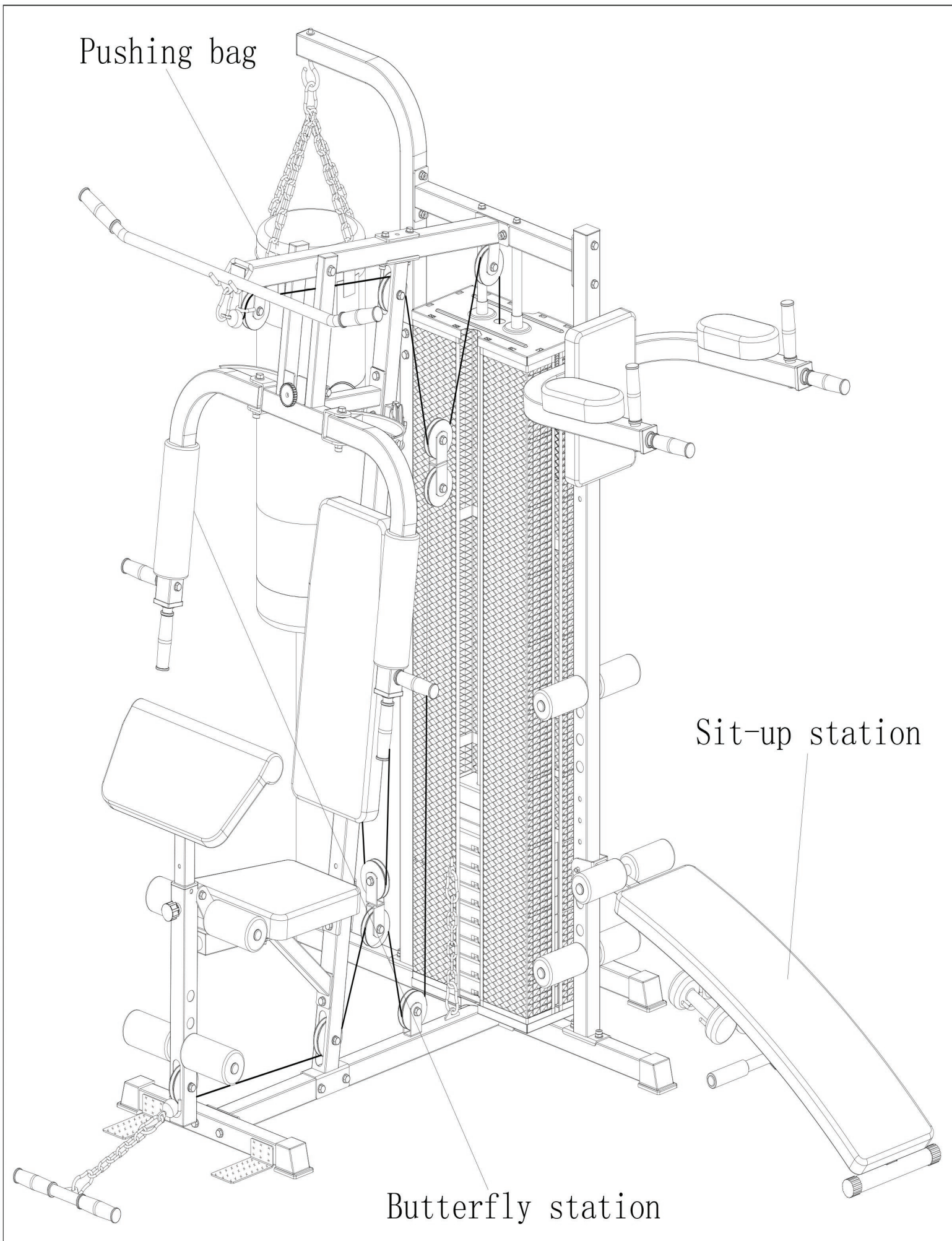



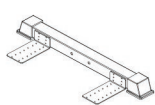
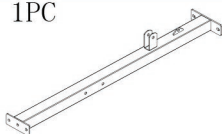
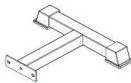
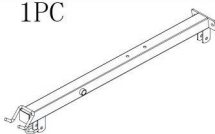
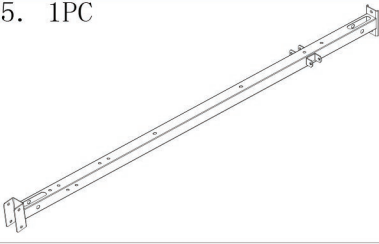
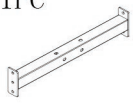
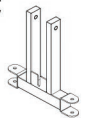
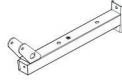
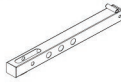
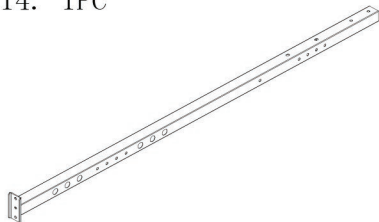



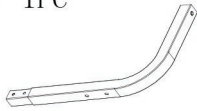
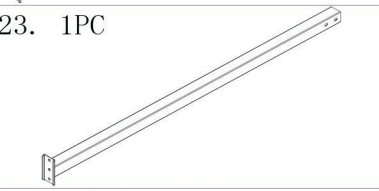
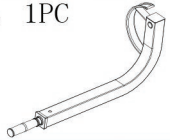
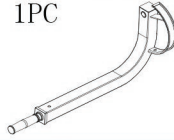

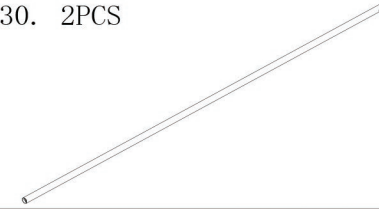
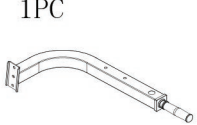



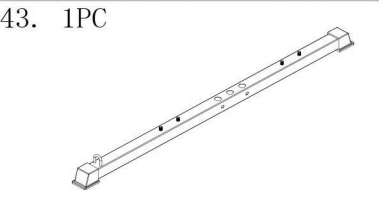







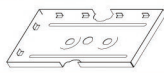
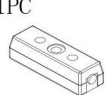
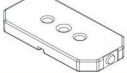













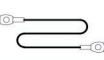
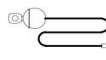











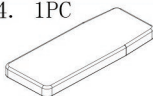



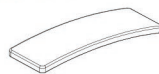







Let children or people with physical or mental limitations, or people who are not familiar with this device, do not use this weight bench!

Please keep in mind that this manual and the safety can only draw your attention to eventual hazard. Logical conclusions and prudent and to handle with this device around must therefore always be provided. So always go with foresight and prudence.

2. Product overview

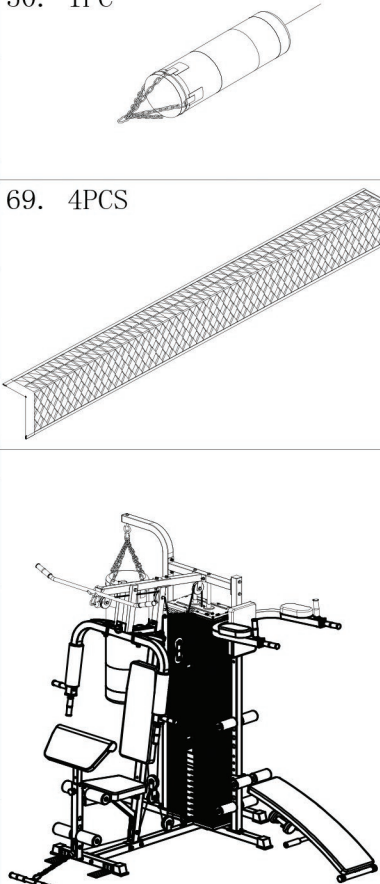

3. Part list / exploded view

1. 1PC 	2. 1PC 	3. 1PC 	4. 1PC 	5. 1PC 	
6. 1PC 	7. 1PC 	8. 1PC 	9. 1PC 	14. 1PC 	
10. 1PC 	11. 1PC 	12. 1PC 	13. 1PC 	23. 1PC 	
15. 1PC 	16. 1PC 	17. 4PCS 	18. 1PC 	30. 2PCS 	
19. 1PC 	20. 1PC 	21. 1PC 	22. 1PC 	43. 1PC 	
24. 1PC 	25. 2PCS 	26. 2PCS 	27. 1PC 	28. 2PCS 	29. 6PCS 
31. 4PCS 	32. 3PCS 	33. 2PCS 	34. 1PC 	35. 9PCS 	36. 1PC 
37. 1PC 	38. 1PC 	39. 2PCS 	40. 1PC 	41. 1PC 	42. 2PCS 
44. 1PC 	45. 1PC 	46. 12PCS 	47. 6PCS 	48. 5PCS 	49. 2PCS 
51. 1PC 	52. 1PC 	53. 1PC 	54. 1PC 	55. 1PC 	56. 4PCS 
57. 1PC 	58. 1PC 	59. 1PC 	60. 2PCS 	61. 6PCS 	62. 2PCS 
63. 1PC 	64. 1PC 	65. 2PCS 	66. 1PC 	67. 1PC 	68. 1PC 
70. 1PC (FOAM) 	71. 2PCS (FOAM) 	72. 1PC 			
73. 16PCS (M10*70) 	74. 9PCS (M10*65) 	75. 3PCS (M10*60) 	76. 10PCS (M10*40) 		
77. 8PCS (M10*20) 	78. 2PCS (M10*25) 	79. 2PCS (M8*70) 	80. 8PCS (M8*65) 		
81. 2PCS (M8*60) 	82. 6PCS (M8*16) 	83. 2PCS (M12*85) 	84. 6PCS (M10) 		
85. 1PC (M12*145) 	86. 2PCS (M6*16) 				
					

1	Querstrebe (1Stk)	Front platform	2	Hauptbasis (1Stk)	Main base
3	Verstärkter Boden	Reinforced base	4	Obere Stützstrebe(1Stk)	Upper support
5	Vertikale Stütze(1Stk)	Vertical support	6	Hintere Stützstrebe (1Stk)	Rear support tube
7	Verbindungsträger (1Stk)	Chest press	8	Sitzhalterung (1Stk)	Seat support
9	Untere Halterung für Polster	Extension lever	10	verstärkte Rohr	Reinforced tube
11	Halterung für Polster (1Stk)	Support for biceps	12	Stützstrebe (1Stk)	Prop support
13	Obere Sandsackstrebe(1Stk)	Bag up support tub	14	Stützstrebe (1Stk)	Deputy support
15	Linke Butterfly-Stütze (1Stk)	Left arm	16	Rechte Butterfly-Stütze (1Stk)	Right arm
17	Metallstrebe kurz (4Stk)	Metal grip	18	obere Armstütze (2Stk)	Right up handrail
19	Obere Armstütze (2Stk)	Left up handrail	20	Sit up Bank	Sit up bench
21	Querstrebe (1Stk)	Cross tube L=570	22	obere Seilzugstange (1Stk)	Upper pulley bar
23	Untere Sandsackstrebe (1stk)	Bag support tub	24	Seilzugstange kurz (1Stk)	Tension bar
25	Rundstrebe kurz (2Stk)	Short foam tub	26	Rundstrebe lang (2Stk)	Long foam tube
27	Gewichtsauswahlstrebe (1Stk)	Weight selector	28	Hantel (2Stk)	Dumbbell
29	Rundpolster Bein (6Stk)	Bone foam	30	Stange (2Stk)	Chrome bars
31	Rundpolster (4Stk)	Foam cylinders	32	Stützplatte (3Stk)	Sheet iron
33	Gewichtsabdeckung	Weight cover support	34	Obere Gewichtsplatte(1Stk)	Upper weights
35	Gewichte (9Stk)	Weight	36	Buchse für Gewichtsbefestigung (1Stk)	Weight block bushing
37	Befestigungspin (1Stk)	Dowel pin \varnothing 10	38	Gegenstück zu ET 67(1Stk)	Big pad
39	Pufferunterlage (2Stk)	Big cushion	40	Schraube für ET 45 (1Stk)	Screw for block lever
41	Rohrschraube (1Stk)	Pipe bolts	42	Rollenhalterung (2Stk)	Pulley support
43	hintere Strebe (1Stk)	Back platform	44	Doppelrolle (1Stk)	Double crutch for Pulleys
45	Schraubplatte für Rolle (2Stk)	Screw plates for pulley	46	Rolle (12Stk)	Pulley
47	Unterlegscheibe (6Stk)	Pulleys push	48	Befestigungsring (5Stk)	Safe knot
49	Kette (2Stk)	chain	50	Sandsack (1Stk)	Boxing bag
51	Seilzug für Butterflystation (1Stk)	Butterfly arms cable	52	Unterer Seilzug (1Stk)	Lower pulley cable
53	Seilzug für Gewichtseinheit (1Stk)	Selection bar cable	54	Befestigungshaken (1Stk)	Ring bolts M10
55	Pin mit Ring \varnothing 10x80	Pin with ring \varnothing 10*80	56	Haken für dumbbell	Hook for dumbbell
57	Dreieckigen Knopf M10x50	Triangular knob	58	Sicherungsstift M16	Locking pin M16
59	Gummipuffer M10	Rubber bumper M10	60	Kunststoff-Stoßstange \varnothing 30x7	Plastic bumper \varnothing 30*7
61	Federring (6Stk)	Big powder metallurgy	62	Befestigungskappen für ET 22(2Stk)	Protector holder
63	Sitzpolster (1Stk)	Seat pad	64	Rückenpolster (1Stk)	Padded back
65	Armpolster oval (2Stk)	Hand pad	66	Rückenstütze (1Stk)	Deputy backboard
67	Armpolster (1Stk)	Cushion for biceps	68	Rückenlehne (1Stk)	Back cushion
69	Gewichtsgehäuseplatte (4Stk)	Weight cover plate	70	kleine Rundpolster (2Stk)	Small foam
71	Große Rundpolster (2Stk)	Big foam for arm	72	Verriegelungsstift	Locking pin 10*170
73	Sechskantschraube (16Stk)	Hex bolts M10x70	74	Sechskantschraube (9Stk)	Hex bolts M10x65
75	Sechskantschraube (3Stk)	Hex bolts M10x60	76	Sechskantschraube (10Stk)	Hex bolts M10x40
77	Sechskantschraube (8Stk)	Hex bolts M10x20	78	Sechskantschraube (2Stk)	Hex bolts M10x25
79	Sechskantschraube (2Stk)	Hex bolts M8x70	80	Sechskantschraube (8Stk)	Hex bolts M8x65
81	Sechskantschraube (2Stk)	Hex bolts M8x60	82	Sechskantschraube (6Stk)	Hex bolts M8x16
83	Sechskantschraube (2Stk)	Hex bolts M12x85	84	Sicherungsmutter (6Stk)	lock nut M10, washer
85	Sechskantschraube (1Stk)	Hex bolts m12x145	86	Sechskantschraube (4Stk)	hex bolts M6x16

4. Installation

STEP 1

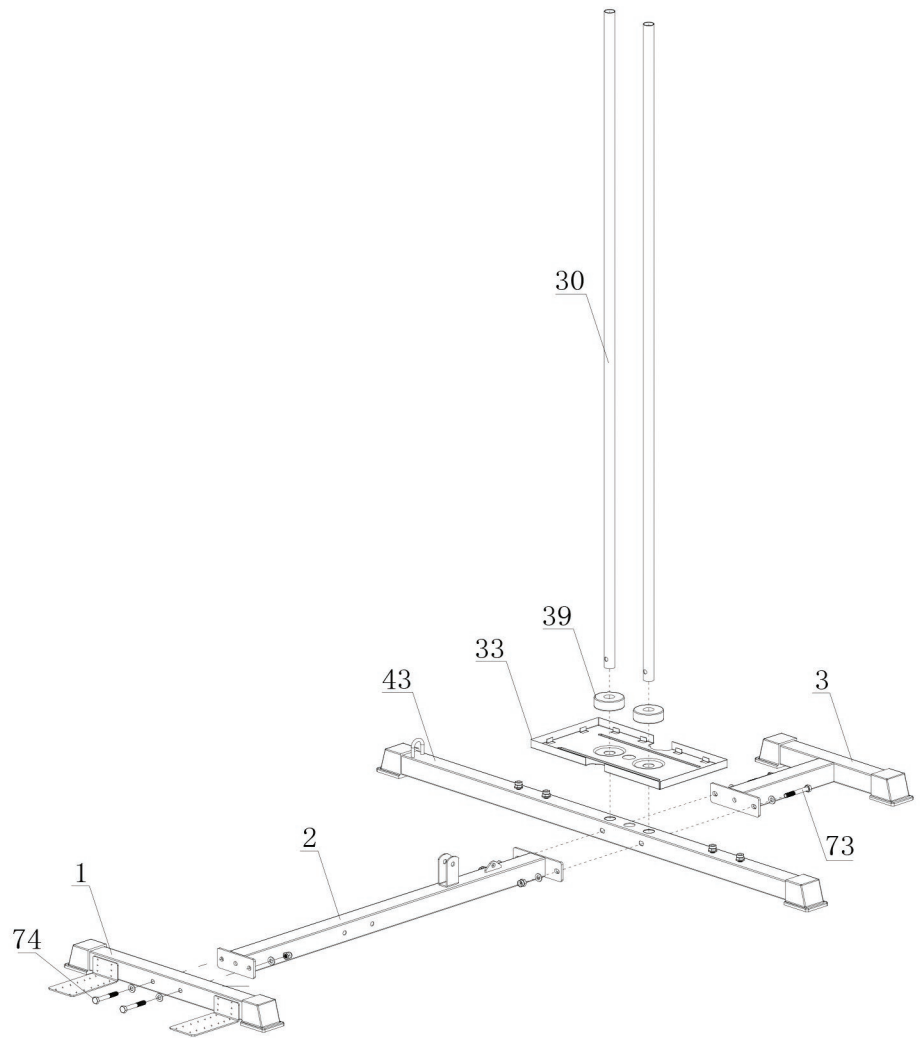

STEP 2

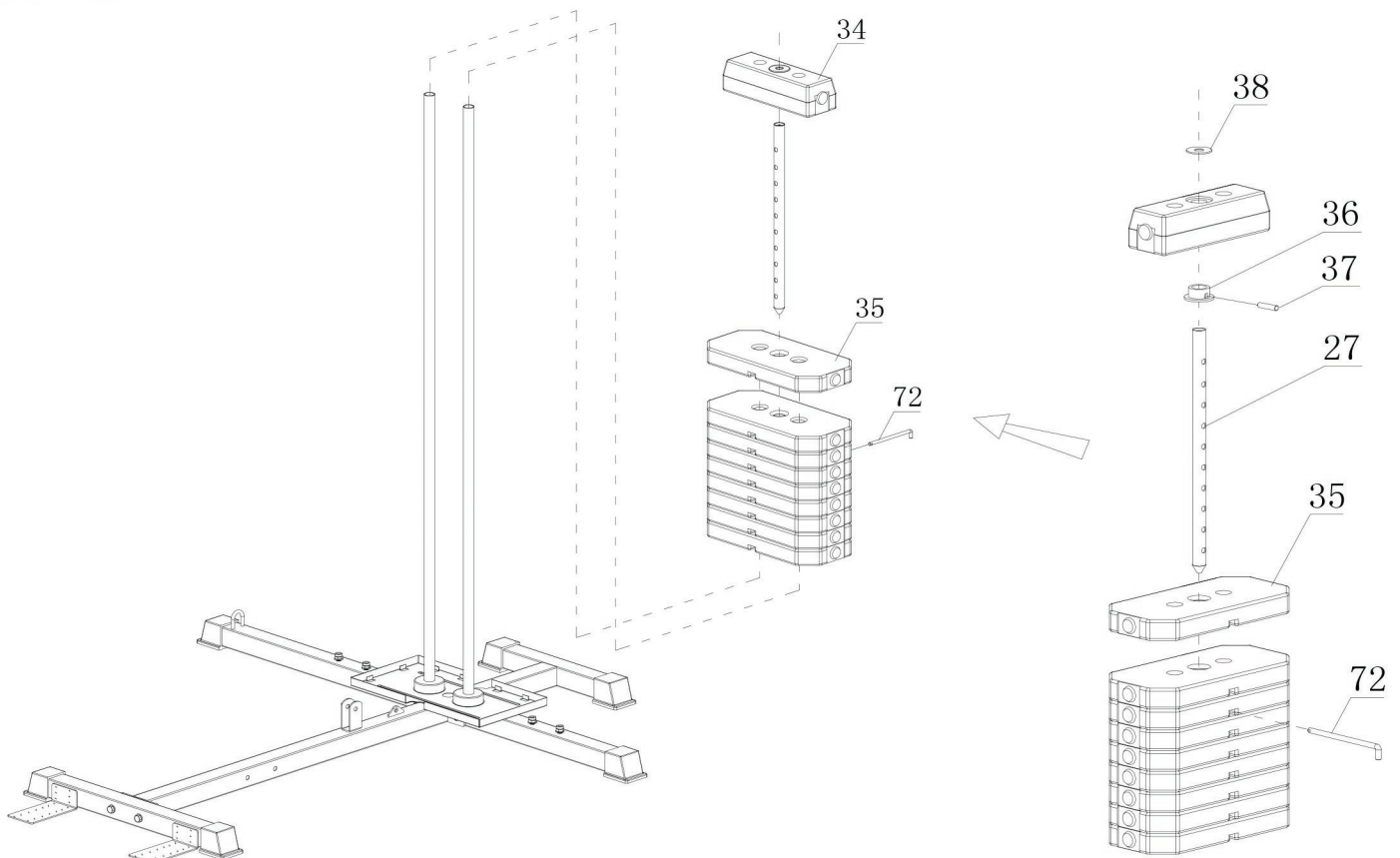

4. Installation

STEP 5

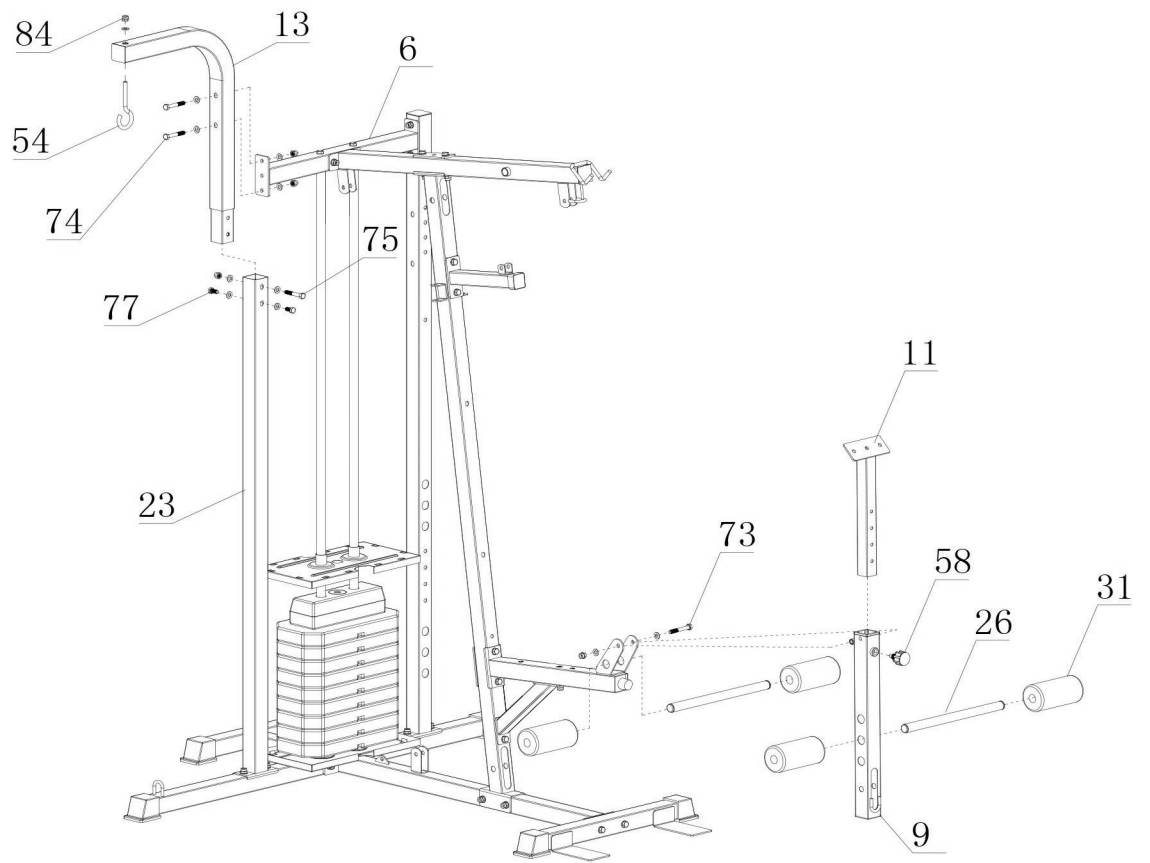

STEP 6

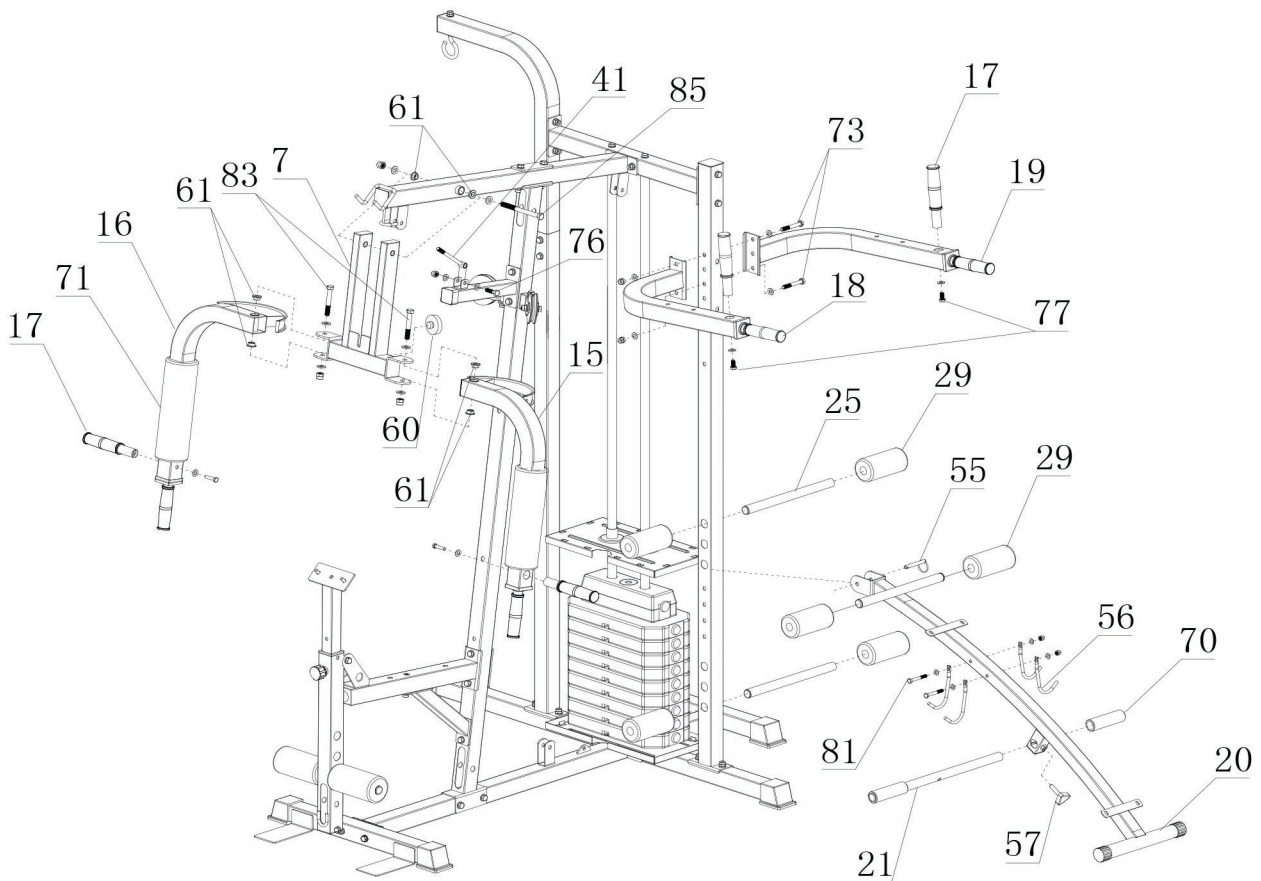

STEP 9

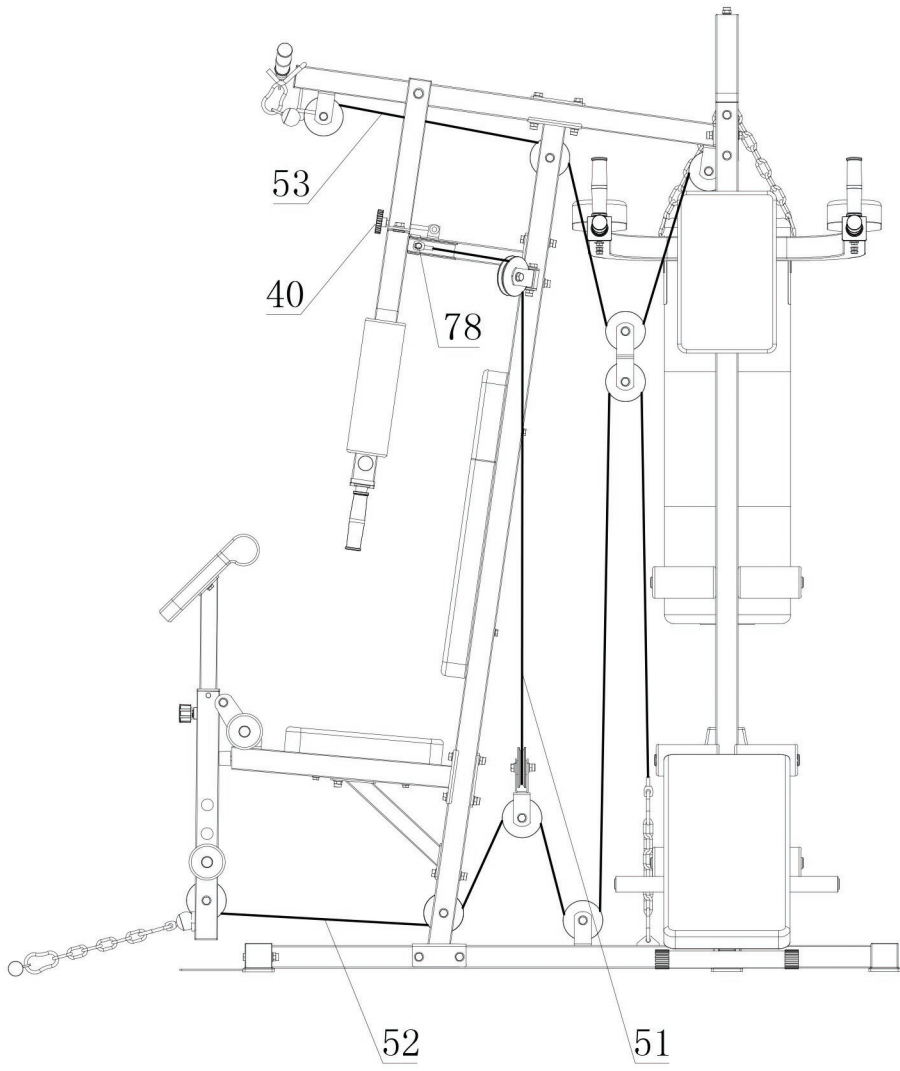

STEP 10

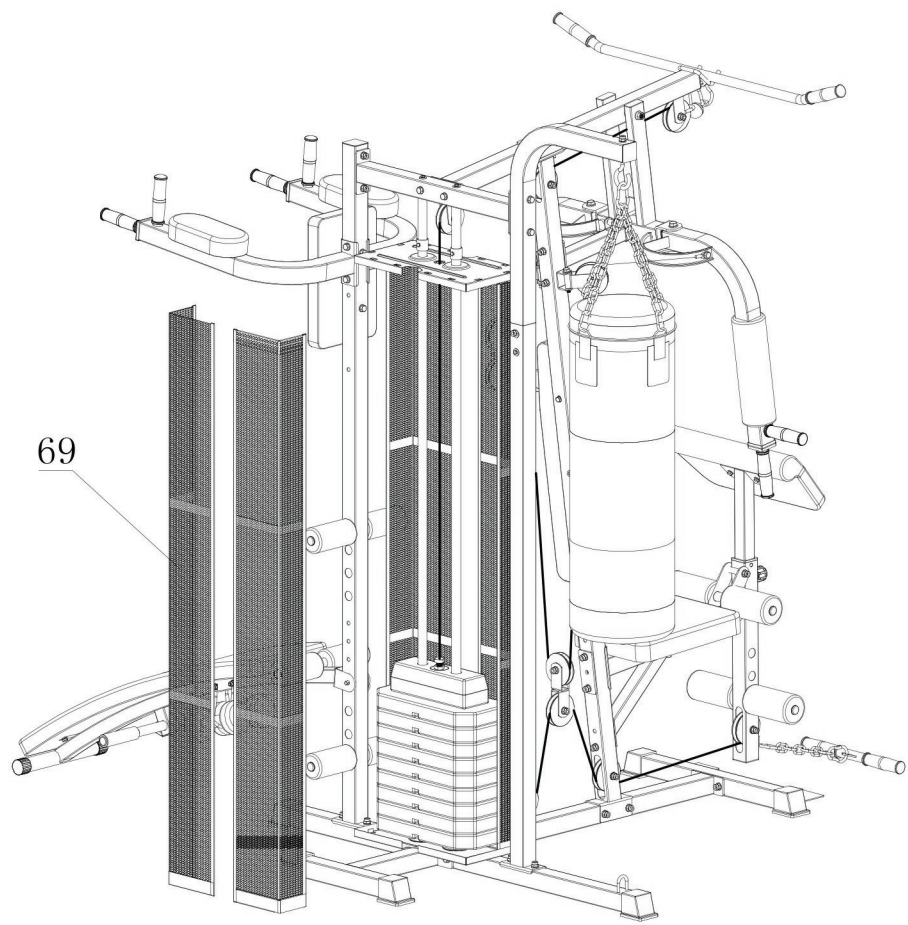

4. Installation

STEP 11

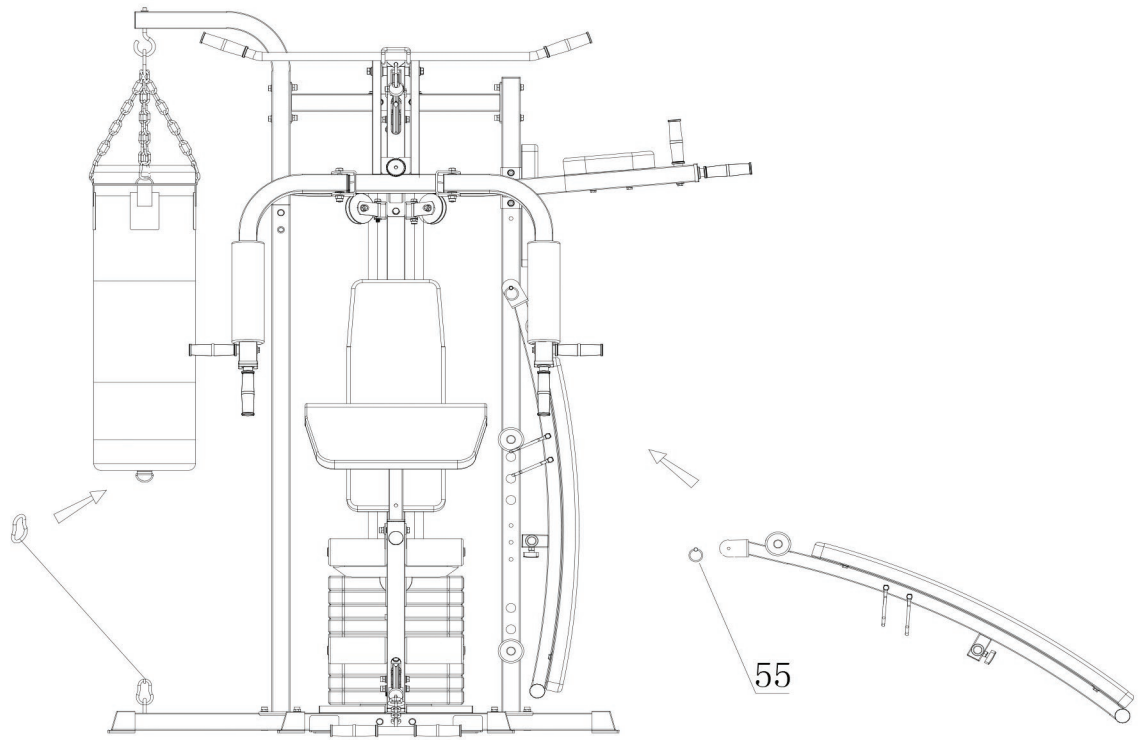

5. operation and use of the item

5.1 location

Use the equipment on a solid, flat level surface with a protective cover for your floor or carpet. For safety the equipment should have at least 0.5 meters of free space all around it.

Use a protective pad before you place the appliance. That should safe the floor regarding damages.

5.2 before training

Warm-up before you start the training. Plan stretching exercise before you start and repeat the stretching exercise after your training to avoid injury.

Always pay attention on a well-balanced training.

Below we show some suggestions on in terms of stretching exercises.

Repeat each exercise 3 times.



Stretch each arm
15 sec.



Hold this position
20 sec.

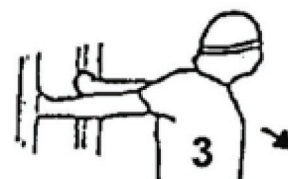

Hold this position 20
sec.



Hold this position
25 sec.

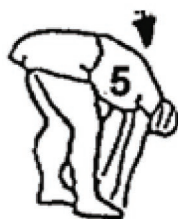

Hold this position
20 sec.



Hold this position
20 sec.



Hold this
position 30
sec.



Stretch every leg 25
sec.



Hold this position
30 sec.

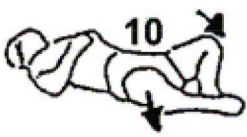

Hold this position
20 sec.



Hold this position 5
sec.

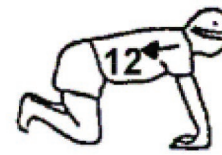

Hold this position
20 sec.

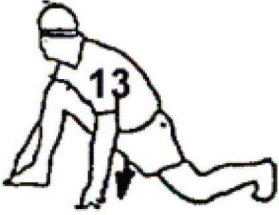

Stretch every leg
25 sec.

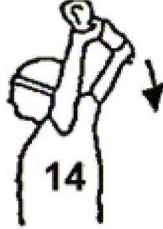

Hold this
position 20
sec.

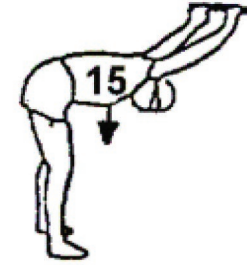

Hold this position
15 sec.

5.3 the training

WARNINGS

PRIOR TO UNDERTAKING ANY PROGRAM OF EXERCISE THAT REQUIRES A MAJOR INCREASE IN PHYSICAL ACTIVITY, CONSULTATION WITH A COMPETENT MEDICAL AUTHORITY IS STRONGLY RECOMMENDED. IN ADDITION, ANYONE WHO HAS A PHYSICAL HANDICAP, SUFFERS FROM A PROLONGED ILLNESS, OR WHO HAS INCREASED RISK FACTORS SUCH AS OBESITY, HYPERTENSION, CARDIO-CIRCULATORY PROBLEMS, ETC., SHOULD CONSULT A COMPETENT MEDICAL AUTHORITY BEFORE UNDERTAKING ANY EXERCISE OR ENGAGING IN A CONTINUING PROGRAM OF EXERCISING.

1.

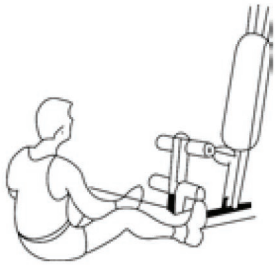
**LOW PULLEY ROW**(TRAPEZIUS-LATISSIMUS
DORSIERECTORSPINAF)

FIT "T"-BAR TO LOW PULLEY SIT WITH FEET AGAINST CROSS-BRACE. LEGS SLIGHTLY BENT STRETCH FORWARD SIT-UP, ARCH YOUR BACK AND PULL TO YOUR WAIST

2

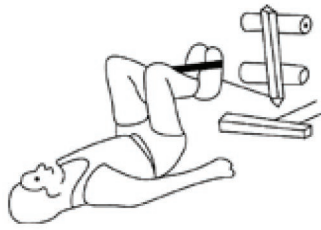
**KNEE RAISE**

(HIT FLEXORS-RECTUS ABDOMINIS)FIT "T"-BAR TO LOW PULLEY LIE ON YOUR BACK WITH LEGS ALMOST STRAIGHT CURL TOES UPWARDS AND PLACE "T"-BAR BETWEEN YOUR FEET. "RAISE" KNEES AS FAR AS POSSIBLE TOWARDS CHEST.

3

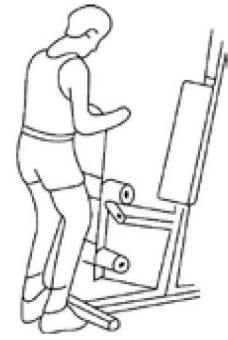
**BICEP CURLS**

(BICEPS-FOREARM FLEXORS)

FIT "T"-BAR TO LOW PULLEY GRIP THE BAR AND STAND WITH YOUR ARMS STRAIGHT AND YOUR ELBOWS LOCKED INTO YOUR BODY. CURL THE BAR UPWARDS AS FAR AS POSSIBLE

4

**PREACHER CURLS**

(BICEPS-FOREARM FLEXORS)

FIT "T"-BAR TO LOW PULLEY AND ROLL PADS. TO TOP HOLE SIT ON SEAT AND LEAN FORWARD GRIP THE BAR AND PLACE ELBOWS AGAINST ROLL PADS, CURL BAR IN AN ARC UPWARDS AS FAR AS POSSIBLE.

5

**PREACHER CURLS-REVERSE GRIP**

(BICEPS-WITH VERY STRONG EMPHASIS ON FOREARM MUSCLES) SAME AS FOR PREACHER CURLS BUT WITH A REVERSE GRIP. YOU MAY FIND THAT YOUR FOREARM GRIP IS THE LIMITATION WITH THIS EXERCISE AND NOT YOUR BICEP STRENGTH.

6

**WRIST CURL**

(FOREARM FLEXORS)

FIT "T" BAR TO LOW PULLEY AND ROLL PAD TO TOP HOLE. REST FOREARMS ON ROLL PADS WHILE GRIPPING BAR. "CURL" YOUR WRISTS WITH AS MUCH RANGE AS POSSIBLE, REVERSE GRIP WORKS

7

**LEG CURL**

(HAMSTRING GROUP)

THIS EXERCISE IS PERFORMED WITH ONE LEG AT A TIME. FIT THE ROLL PADS TO THE TOP HOLE. HOOK YOUR LEG AROUND WITH YOUR KNEE AGAINST THE TOP PAD CURL AS FAR AS POSSIBLE.

8

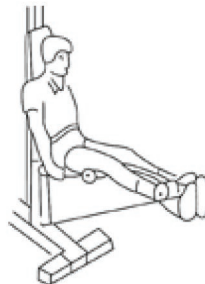
**LEG EXTENSIONS**

(QUADRICEPS)

FIT THE ROLL PADS TO THE BOTTOM HOLE. HOOK YOUR LEGS AROUND THE ROLL PADS AND GRIP THE BOTTOM OF THE SEAT. SLOWLY STRAIGHTEN YOUR LEGS

9

**CRUNCHES**

(RECTUS ABDOMINIS-SERRATUS-LOWER LATISSIMUS DORSI) FIT "T" BAR TO HIGH PULLEY AND ROLL PADS TO BOTTOM HOLE. HOOK YOUR LEGS AROUND THE ROLL PADS AND GRIP THE BAR BEND AT THE WAIST AND CURL FORWARD AND DOWN AS FAR AS POSSIBLE.